



Maharashtra State Electricity Distribution Company Limited

SPEC NO.STORES: MSC-II/DT/200 KVA (Conventional without CSP)/2011

TECHNICAL SPECIFICATION

FOR

**200 kVA, 11/0.433 kV, 22/0.433 kV THREE PHASE, CONVENTIONAL DISTRIBUTION
TRANSFORMERS WITHOUT CSP FEATURE**

FOR

DISTRIBUTION SYSTEM

IN

MSEDCL

INDEX

Clause No.	Contents
1	Scope
2	System Particulars
3	Service Condition
4	Applicable Standards
5	Specific Technical requirement
6	Design & Construction
6.1	Core
6.2	Windings
6.3	Losses
6.4	Insulation Material & Clearances
6.5	Impedance Value
6.6	Tank
7	Heat Dissipation
8	Total minimum oil volume
9	Conservator.
10	Breathers.
11	Terminals
12	Bushing and connections
13	Internal Connections
14	Tank base channel
15	Terminal Marking Plate & Rating Plate
16	Fittings
17	Lightning Arrestor
18	Transformer Oil
19	Tests & Inspection
20	Challenge Testing
21	Type Tests
22	Drawings
23	Rejection
24	Cleaning & Painting
25	Guaranteed Technical Particulars

26	Testing facilities
27	Submission of Routine Test Certificate
28	Stage Inspection
29	Testing of all distribution transformers for no load and full load losses.
30	Random Sample Testing
31	Inspection & Testing of Transformer Oil
32	Quality Assurance
33	Qualifying Requirements
34	Final Inspection
35	Performance Guarantee
36	Cost Data Sheet
37	Schedule
Schedule A	Guaranteed and Other Technical Particulars
Schedule B	Tenderer's experience
Annexure-I	Air Pressure Test
Annexure-II	Unbalance Current Test
Annexure-III	Temperature Rise Test

MAHARASHTRA STATE ELECTRICITY DISTRIBUTION COMPANY

TECHNICAL SPECIFICATION FOR 200 kVA, 11/0.433 & 22/ 0.433 kV, THREE PHASE, DISTRIBUTION TRANSFORMERS WITH CSP FEATURE.

SPEC NO. STORES: MSC-II/DT/200 KVA (Conventional without CSP)/2011

1 Scope:-

- 1.1 This specification covers design, manufacturing, testing and delivery of **200 kVA, 11/0.433 & 22/ 0.433 kV THREE PHASE, Oil immersed, Air Natural (ONAN) DISTRIBUTION TRANSFORMERS (Conventional) WITHOUT CSP FEATURE** suitable for 11 kV and 22 kV, 50 Hz, Distribution system.
- 1.2 The equipment offered shall be complete with all parts necessary for their effective and trouble-free operation. Such parts will be deemed to be within the scope of the supply irrespective of whether they are specifically indicated in the commercial order or not.
- 1.3 It is not the intent to specify herein complete details of design and construction. The equipment offered shall conform to the relevant standards and be of high quality, sturdy, robust and of good design and workmanship complete in all respects and capable to perform continuous and satisfactory operations in the actual service conditions at site and shall have sufficiently long life in service as per statutory requirements.
- 1.4 The design and constructional aspects of materials shall not withstanding any anomalies, discrepancies, omissions, in-completeness, etc. in these specifications and will be subject to good engineering practice in conformity with the required quality of the product, and to such tolerances, allowances and requirements for clearances etc. as are necessary by virtue of various stipulations in that respect in the relevant Indian Standards, IEC standards, I.E. Rules, I.E. Act and other statutory provisions.
- 1.5 The Bidder/supplier shall bind himself to abide by these considerations to the entire satisfaction of the purchaser and will be required to adjust such details at no extra cost to the purchaser over and above the tendered rates and prices.
- 1.6 Tolerances:
The tolerance of guaranteed performance figures shall be as specified in the (Part-I) table 7 of latest issue of IS 2026 or relevant International Standard except wherever specified otherwise in this specification.

2 System Particulars:-

The transformers shall be suitable for outdoor installation with following system particulars and they should be suitable for service under fluctuations in supply voltage as permissible under Indian Electricity Rules

- | | | | |
|-----|--------------------------------------|---|--------------------------------|
| 2.1 | Nominal System Voltage | : | 11 kV or 22 kV |
| 2.2 | Corresponding Highest System Voltage | : | 12 kV or 24 kV |
| 2.3 | Neutral earthing | : | Solidly earthed |
| 2.4 | Frequency | : | 50 Hz with ± 3 % tolerance |
| 2.5 | Number of Phase | : | 3 |

3 SERVICE CONDITIONS:

3.1 Equipment supplied against the specification shall be suitable for satisfactory operation under the following tropical conditions:-

- i Max. ambient air temperature : 40 Deg. C
- ii Max. relative humidity : 100 %
- iii Max. annual rainfall : 1450 mm
- iv Max. wind pressure : 150 kg/sq.m.
- v Max. altitude above mean sea level : 1000 mtrs.
- vi Isoceraunic level : 50
- vii Seismic level(Horizontal acceleration) : 0.3 g.
- viii Climatic Condition Moderately hot and humid tropical climate conducive to rust and fungus growth.
- ix Reference Ambient Temperature for temperature rise : 40 Deg C

3.2 The climatic conditions are prone to wide variations in ambient conditions and hence the equipment shall be of suitable design to work satisfactorily under these conditions.

4 APPLICABLE STANDARDS:-

4.1 The design, manufacture and performance of the equipment shall comply with all currently applicable statutes, regulations and safety codes.

Nothing in this specification shall be construed to relieve the bidder off his responsibilities.

4.2 The Distribution Transformers shall conform to IS: 2026 as amended up to date or other International Standards for equal or better performance.

4.3 Unless otherwise specified, the equipment offered shall conform to latest applicable Indian, IEC, British or U.S.A. Standards and in particular, to the following:-

a.	<i>IS 2026(Part I,II,IV)/1997, (Part-III)/1981, (Part-V)/1994</i>	Power Transformer
b.	IS:335/1993	New insulating oil- Specification (fourth revision)
c.	IS:2099/1986, IS: 7421-1988, IS:3347 (Part-I /Sec-2)-1979, IS:3347 (Part-I /Sec-1)-1982 amended up to date	Bushing
d.	IS 5	Colours for ready mixed paints and enamels.
e.	IS 13730 (Part-27)1996	Specification for particular types of

		winding wires.
f.	IS: 3073/1974, IS: 3070(Part-II)	Specifications for L.A's
g.	CBIP Publication No.295:2006	Manual on transformers

4.4 In case of conflict arising out due to variations between the applicable standard and the standards specified herein the provisions of this specification should prevail.

5 Specific Technical requirement:

5.1 Standard kVA Ratings:-

The standard ratings for transformer shall be 200 kVA.

5.2 Nominal voltage ratings

i Primary voltage : 11 kV/ 22 kV

ii Secondary voltage : 0.433 kV

5.2.1 Winding connections:-

i. H.V. Winding : Delta (Δ)

ii. L.V. Winding : Star (Y)

The neutral of the L.V. winding shall be brought out to a separate insulated terminal. The voltage group shall be Dyn-11.

5.3 Temperature Rise:

i The temperature rise for top oil over an ambient temperature of 40° C should be 45° C maximum (measured by thermometer in accordance with IS 2026.)

ii Temperature rise for winding over an ambient temperature of 40° C should be 50° C maximum (measured by resistance method in accordance with IS 2026.)

5.4 No load voltage ratio:-

The no load voltage ratio shall be 11000/433 Volts or 22000/433 Volts.

6 Design & construction

6.1 Core

i The core shall be stacked/ wound type.

a) **For Stack core :-** The core shall be of high grade cold rolled grain oriented (C.R.G.O) annealed steel lamination having low loss and good grain properties, coated with hot oil proof insulation, bolted together to the frames firmly to prevent vibration or noise. All core clamping bolts shall be effectively insulated. The complete design of core must ensure permanency of the core losses with continuous working of the transformers.

b) For Wound core :-

The core shall be 'C' type construction of high grade cold rolled grain oriented (C.R.G.O.) annealed steel lamination having low loss and good grain properties,

coated hot oil proof insulation or Amorphous core material. The complete design of core must ensure permanency of the core losses with continuous working of the transformers. The core material shall not be brittle in case of CRGO material.

Core clamping for C.R.G.O./Amorphous Wound core type transformers shall be as follows:

1. Core clamping shall be with top and bottom U- shaped core clamps made of sheet steel clamped
 2. M.S. core clamps shall be painted with oil-resistant paint.
 3. Suitable provision shall be made in the bottom core clamp / bottom plate of the transformer to arrest movement of the active part.
 4. Core shall be clamped by 16 mm diameter MS Tie rods.
- ii The grade of core laminations shall be M4 or better.
- The successful bidder, shall be required to submit the manufacturer's test report showing the Watt Loss per kg and the thickness of the core lamination, to ascertain the quality of Core materials.
- The purchaser reserves the right to get sample of the core material tested at any Government recognized laboratory.
- iii The transformer core shall not be saturated for any value of V/f ratio to the extent of 112.5% of the rated value of V/f ratio (i.e. 11000/50 or 22000/50) (due to combined effect of voltage and frequency) up to 12.5% without injurious heating at full load conditions and will not get saturated. The bidder shall furnish necessary design data in support of this situation.
- iv Flux density:-
- Flux density should not be more than 1.55 Tesla at the rated voltage and frequency. The value of the flux density allowed in the design shall be clearly stated in the offer along with graph.
- v The No load current at rated voltage shall not exceed the percentage as given below.
- The no load current of 200 kVA transformer shall not exceed 2% the full load current. The no load current shall not exceed 2 times that at rated voltage when the applied voltage is 112.5%.
- vi Number of steps of core shall be minimum of

200 kVA	7 standard steps
---------	------------------

6.2 Winding:-

- i Materials:

Double paper covered **Aluminum** conductor shall be used for HV and LV winding for 11 kV class and Double paper covered copper conductor shall be used for HV and LV winding for 22 kV class.

ii Current Density:

Current density for HV and LV winding should not be more than 2.8 A/sq. mm for Copper and 1.6 A / sq.mm for Aluminium conductor.

iii L.V. Neutral formation shall be at top.

6.3 Losses :

The No load losses and Load Losses of 200 kVA, 11 /0.433 kV and 22/ 0.433 kV transformers at rated voltage and rated frequency are specified as follows:

TABLE – 1

KVA Rating	Voltage Ratio in kilovolts	No Load Losses (Watts)	Load Losses (Watts) at 75 °C
200	11/0.433	500	3000
200	22/0.433	470	3000

However, in both cases (No Load Losses and Load Losses) the tolerances as allowable as per IS-2026 (Part-I) 1977 amended up to date, shall be applicable In case the actual losses considering tolerances exceed the guaranteed losses(No Load Losses + IS tolerance, Load Losses + IS tolerance) the transformers shall be rejected at the risk, cost and responsibility of the supplier.

The values guaranteed in G.T.P. for flux density, no load current at rated voltage, no load current at 112.5% of rated voltage and no load loss at rated voltage shall be individually met.

6.4 **Insulation material & clearances:**

i Materials - Makes of Electrical grade insulating craft paper, Press Board, Perma wood/ Haldi wood insulation shall be declared in GTP by the bidder. The test reports for all properties as per relevant I.S. amended up to date shall be submitted during inspection.

ii The electrical clearance between the winding and body of the tank (between inside surface of the tank and outside edge of the windings) should be minimum 30 mm and 40 mm for 11 kV and 22 kV class respectively.

iii. Minimum external clearances of bushing terminals

		<u>11 kV</u>	<u>22 kV</u>
HV	Ph to Ph	255 mm	330 mm
	Ph to E	140 mm	230 mm

LV	Ph-to-Ph	75 mm.	75 mm
	Ph to E	40 mm.	40 mm

6.5 Impedance Value-

The percentage impedance at 75 °C shall be **5%** for both 11 kV and 22 kV (IS tolerance of $\pm 10\%$ is applicable) class distribution transformers.

6.6 Tank

6.6.1 The transformer tank shall be made up of prime quality M.S. sheets of rectangular shape. No other shape will be accepted. The transformer tank shall be of robust construction. All joints of tank and fittings should be oil tight and no bulging shall occur during service. The tank design shall be such that the core and windings can be lifted freely. The tank plates shall be of such strength that the complete transformer when filled with oil may be lifted bodily by means of the lifting lugs provided. Tank inside shall be painted by varnish. Top cover plate shall be slightly sloping; approximately 5 to 10 deg. towards HV bushing and edges of cover plate should be bent downwards so as to avoid entry of water through the cover plate gasket. The width of bend plate shall be 25 mm min. The top cover shall have no cut at point of lifting lug. The rectangular tank shall be fabricated by welding at corners.

6.6.2 The transformer tank of corrugation is also acceptable, however shape of tank shall be rectangular only. The corrugation sheets thickness shall be of minimum 1.6mm. Corrugation panel shall be used for cooling. The transformer shall be capable of giving continuous rated output without exceeding the specified temperature rise. Bidder shall submit the detailed calculation sheet alongwith offer. The safe guard angle frame 50X50X5 mm shall be welded for corrugated side to the tank.

6.6.3 In rectangular shape tanks, horizontal or vertical joints in tank side walls and its bottom or top cover will be not allowed. In addition the cover of the main tank shall be provided with an air release plug.

Side wall thickness : 4 mm. (min.)

Top and bottom plate thickness : 6 mm. (min.)

6.6.4 Reinforced by welded angle 50X50X5 MM on all the outside walls on the edge of tank to form two equal compartments. The permanent deflection is not more than 5mm up to 750 mm length and 6mm up to 1250 mm length when transformer tank without oil is subject to air pressure of 35 KPa above atmospheric pressure for 30 min. Pressure test shall be performed carefully at the time of 1st stage inspection only to confirm the adequacy of reinforcement angle and gauge of the tank and certified by E.E. (IW).

6.6.5 All welding operations to be carried out by MIG process.

6.6.6 Lifting lugs: 4 nos. welded heavy duty lifting lugs of MS plate of 8mm thickness suitably reinforced by vertical supporting flat of same thickness as of lug welded edgewise below the lug on the side wall, up to reinforcing angle. They shall be so extended that cutting of bend plate is not required. 2 nos welded heavy duty lifting lugs of MS Plate of 8 mm thickness should be on the top plate of transformer.

- 6.6.7 Pulling lugs: 4 nos. of welded heavy duty pulling lugs of MS plate of 8mm thickness shall be provided to pull the transformer horizontally.
- 6.6.8 Top cover fixing bolts: GI nut bolts of 1/2" diameter with one plain washer shall be used for top cover fixing, spaced at 4" apart. 6 mm neoprene bonded cork oil resistance gaskets conforming to type B/C IS 4253 Part-II amended up to date will be placed between tank and cover plate.
- 6.6.9 Vertical clearance: - The height of the tank shall be such that minimum vertical clearance up to the top cover plate of 120 mm is achieved from top yoke.

7.0 Heat Dissipation:

- a) Heat dissipation by tank walls excluding top and bottom should be 500 W/ sq.m.
- b) Heat dissipation by fin type radiator 1.25 mm thick will be worked out on the basis of manufacturers data sheet. The tenderer shall submit the calculation sheet with the offer or the offer shall stand rejected.
- c) Radiators shall be provided on both HV and LV bushing side of the transformer tank wall and shall be of fin type. They should be fixed at right angle to the sides and not diagonally. The size of the radiator shall be such that it covers at least 50% of the bottom yoke, full core and complete top yoke.

8.0 Total Minimum Oil Volume :

Sr.No.	KVA rating	Voltage Ratio in Volts	Oil in liters (exclusive of oil absorbed in core & coil assembly)
1	200 kVA	11000/433	400
		22000/433	420

Note: Transformer shall be supplied complete with first filling of oil and 10 % extra of total volume of oil in separate container/ drum to the concerned stores. Detailed calculation of absorption should be submitted.

9.0 Conservator:

- a) The total volume of conservator shall be such as to contain 10% of total quantity of oil. Normally 3% quantity of the total oil will be contained in the conservator. Dimension of the conservator shall be indicated on the General Arrangement Drawing.
- b) Oil level indicator shall be provided on the side which will be with fully covered detachable flange with single gasket and tightened with MS nut-bolt.
- c) The inside diameter of the pipe connecting the conservator to the main tank shall be within 20 to 50 mm and it should be project into the conservator in such way that its end is approximately 20mm above the totem of the conservator so as to create a sump for collection of impurities. The minimum oil level (corresponding to (-) 5 deg.) should be above the sump level.
- d) The pipe from conservator tank connecting to main tank shall be of 30 mm (min.) dia and shall have a slopping flap so that the oil falling from the pipe shall not fall directly on the active job and shall fall on the side walls only.

- e) The conservator shall be provided with the drain plug and a filling hole (30mm dia) with cover.

10.0 Breather:

Breather joints will be screwed type. It shall have die-cast aluminum body or of **Poly propylene** materials and inside container for silica gel shall be of tin sheet, in case of aluminum die cast breather. Makes of the breather shall be subject to purchaser's approval. Volume of breathers shall be suitable for 500 gm. of silica gel. The make and design of breather shall be subject to approval of **C.E. (Stores)**.

11.0 Terminals:

- a. **Brass rods 12 mm. diameter for HT** with necessary nuts, check-nuts and plain thick tinned washer.
- b. **Tinned Copper Rods of 20 mm diameter** for 63/100 kVA distribution transformers for LT extension with suitable cable lugs, necessary nuts, check-nuts and plain thick tinned washer.

12.0 Bushings & Connections:

- 12.1 For 11 kV class 12 kV bushing, for 22 kV class 24 kV bushing shall be used and for 433 volts 1.0 kV bushing shall be used. Bushings of the same voltage class shall be interchangeable. Bushings with plain shed shall be as per relevant IS:3347 amended up to date. HV bushings shall be mounted on the top of the transformer tank & LV bushings shall be mounted on side of the transformer tank.
- 12.2 HV bushings shall be mounted on curvature shaped embossed plate, in such a way that all H.V. Bushings shall remain parallel and at equi-distance throughout. Bushings having type tested, as per relevant IS amended up to date shall only be acceptable.
- 12.3 The minimum creepage distance for both HV & LV Bushings shall not be less than 25 mm per kV.

13.0 Internal connections:

- 13.1 H.V. Winding :
 - i. In case of H.V. winding all jumpers from winding to bushing shall have cross section larger than winding conductor.
 - ii. Inter coil connection shall be by crimping and brazing.
 - iii. In case of Al/Copper Winding Delta joints shall be with crimping and Brazing only.
 - iv. Lead from delta joint shall be connected to bushing rod by brazing only.
- 13.2 L.V. Winding :
 - i. L.T. Star point shall be formed of Aluminium/Copper flat of sufficient length. Lead from winding shall be connected to the flat by crimping and brazing.
 - ii. Firm connections of L.T. winding to bushing shall be made of adequate size of 'L' shaped flat. Connection of L.T. Coil lead to 'L' shape flat shall be by crimping and brazing. Alternatively 'L' shape lug of adequate capacity effectively crimped shall be acceptable.

- iii. `L' shape flat/lug shall be clamped to L.V. Bushing metal part by using nut, lock-nut and washers.
- iv For Aluminum windings, L&T Alkapee aluminum brazing rods with suitable flux shall be used. For copper winding crimping and silver brazing alloy shall be used.

14.0 Tank base channel :

It should be of two numbers of 100mm x 50 mm channel for 200 kVA transformers

15.0 Terminal Marking Plates and Rating Plates :

Terminals shall be provided with terminal marking plates. The transformer shall be provided with riveted rating plate of minimum 18 SWG aluminum anodized material sheet in a visible position. The entries of the rating plate shall be indelibly marked (i.e. by etching, engraving or stamping).

Marking as `M.S.E.D.C.L'S and `Sr. No.' of transformer shall be engraved on transformer main tank below L.T. bushings.

The name of the company, order No., capacity, month and year of manufacturing shall be engraved on separate plate which shall be firmly welded to main tank and shall form integral part of the tank.

16.0 Fittings:

The fittings on the transformers shall be as under:

1	Rating and diagram plate	1 no.
2	Earthing terminals with lugs.	2 nos.
3	Lifting lugs	6 nos. (4 nos for tank and 2 nos for top plate of the transformer)
4	Oil filling hole with cap (on conservator)	1 no
5	Drain valve - 32mm for all T/Fs (Drain valve shall be covered with metallic box spot welded to tank)	1 no
6	Conservator with drain plug.	1 no
7	Thermometer pocket	1 no
8	Explosion vent	1 no
9	Silica gel breather	1 no
10	Platform mounting channel (with hole suitable for axle of rollers)	2 nos
11	Oil level gauge indicating 3 positions of oil marked as below :	1no
	Minimum (-) 5 deg.C.	
	Normal 30 deg.C	
	Maximum 98 deg.C.	
12	HT & LT bushing	3 nos. of HT bushing and 4 nos. of

		LT bushing shall be provided. Each bushing (HV & LV) should be provided with 3 nos. of brass nuts and 2 plain brass washers.
13	Radiators	As per Cl. No. 7 (C)
14	Lightening Arrestors for HT bushings	3 nos
15	Pulling lugs	4 nos
16	Rollers	4 nos
17.	Filter valve (32 mm dia)	1no

17.0 Lightening Arrestors:

The Lightening Arrestors (Disconnecter type) of high surge capacity of 9 kV(Vrms), 5 kA(8/20 micro wave shape) for 11 kV class transformers and 18 kV(Vrms), 5 kA (8/20 micro wave shape) for 22 kV class transformers, conforming to IS: 3070/1974 shall be mounted on the HV bushings of transformer, clamped securely to the tank, to protect the transformer and associated line equipment from the occasional high voltage surges resulting from lighting or switching operations. The earthing terminal of the lightening arresters shall be grounded separately.

18.0 Transformer Oil

Transformer oil to be used in all the Distribution transformers shall comply with the requirements of latest IS 335/1983 amended up to date thereof. In addition the oil should conform to 'Ageing Characteristics' specified below for New Oil and Oil in Transformers. Type test certificates of oil being used shall be produced to EE (IW) at the time of stage inspection.

New oil - Ageing characteristics after accelerated ageing test 96 hrs at 115° C (open beaker method with copper catalyst):

- i. Specific Resistance (Resistivity)
 - a) at 20 ° C :- 2.5×10^{12} Ohm-Cm (Min)
 - b) at 90 ° C :- 0.2×10^{12} Ohm-Cm (Min)
- ii Dielectric dissipation factor - 0.20 (Max. tan delta) at 90 ° C.
- iii Total acidity mg/KOH/gm - 0.05 (Max)
- iv Total sludge value (%) by weight - 0.05 (Max.)
- v The method of testing these aging characteristics is given in Appendix - C of IS 335 amended up to date.
- vi. Oil filled in Transformers:

The important characteristics of the transformer oil after it is filled in the transformer (within 3 months of filling) shall be as follows: -

Sr.No.	Characteristics	Specifications
1.	Electric Strength (Breakdown voltage)	30 kV (Min)
2.	Dielectric dissipation factor (Tan Delta) at 90 deg.C.)	0.01 (Max)
3.	Specific Resistance (Resistivity) at 27 deg. C (ohm-cm)	10×10^{12}
4.	Flash Point, P.M. (closed)	140 ° C (Min)
5.	Inter facial tension at 27 ° C.	0.03N/M (Min)
6.	Neutralization value (total acidity)	0.05Mg.KOH/g m (Max.)
7	Water content PPM	35 (Max)

19.0 Test and Inspection:-

19.1 Routine Tests:-

i. All transformers shall be subjected to the following routine tests at the manufacturer's works. The tests are to be carried out in accordance with the details specified in IS 2026 or as agreed upon between the purchaser and the manufacturer.

1. Measurement of winding resistance.
2. Ratio, polarity and phase relationship.
3. Impedance voltage.
4. Load losses.
5. No-load losses and No-load current.
6. Insulation resistance.
7. Induced over voltage withstand.
8. Separate source voltages withstand.

ii. All the routine tests shall be conducted in the suppliers' laboratory at their cost.

iii. Heat run test shall be arranged free of cost on the unit selected from the 1st lot by Executive Engineer / Authorized Representative.

iv. The calculations to confirm the thermal ability as per Clause no. 8.1 of latest IS: 2026 Part-I or equivalent International Standard shall be submitted to Executive Engineer (IW).

20.0 Challenge Testing:

The manufacturer can also request challenge testing for any test based on specification and losses. The challenger would request for testing with testing fees. The challenge test fees are proposed at least three times the cost of testing. This is likely to deter unnecessary challenges. The challenger would have the opportunity to select the sample from the store and any such challenge should be made within the guarantee period. The party challenged, challenger and the utility could witness the challenge testing.

The challenge testing would cover following tests:

1. Measurement of magnetizing current.

2. No load losses test.
3. Full Load losses test .
4. Temperature rise test.

The challenge test could be conducted at NABL Laboratory, like ERDA and CPRI. If the values are within the limits the products gets confirmed else not confirmed. No positive tolerances in losses is permitted. If the product is not confirmed the manufacturer would pay the challenge fee and challenger would get the fee refunded. However as a redressal system the challenger would be allow to ask for fresh testing of two or more samples from the store and the same be tested in NABL Laboratory in presence of party challenge, challenger and the utility.

If any one of the above sample does not confirm the test, then the product is said to have failed the test. In such cases the manufacturer will be declared as unsuccessful manufacturer for the said product with wide publicity and would not allow to complete in tenders of the MSEDCL for the period of three years and heavy penalty would be imposed.

21.0 Type Tests:-

- 21.1 In addition to routine test as above Impulse voltage Withstand test and Dynamic Short Circuit Test as under shall be successfully carried out at laboratories accredited by National Accreditation Board for Testing and Calibration Laboratories (NABL)in accordance with IS 2026/1977 as amended from time to time and technical specifications, within the last 5 (five) years prior to the date of offer. The bidder shall furnish the following type tests reports (along with General arrangement drawing, Rating and Diagram Plate and Internal Constructional drawing) along with the offer.
 - i. Impulse Voltage with stand Test on all three HV phases chopped on tail.
 - ii. Dynamic Short circuit Test
- 21.2 The following balance type test should be carried at the manufacturer's works invariably in the presence of MSEDCL's representative at the time of inspection from the first lot.
 - i. Temperature Rise Test
 - ii Air pressure test as per clause no. 22.5 of IS:1180 (Part I)/1989
 - iii Unbalanced current test – unbalanced current should not be more than 2% of full load current.
- 21.3 The type test reports should be submitted and got approved from the **Chief Engineer (Stores)** before commencement of supply.
- 21.4 In case of any of the following, the offer may be considered for placement of order.
 - i. If above tests are carried out beyond 5 years
 - ii. Impulse Voltage Withstand test and Dynamic Short Circuit test carried out not from NABL approved Laboratory.
 - iii. If there is any change in the design/ type of old type tested transformers to be offered against this specification.

However, successful bidders have to carry out the type tests at the laboratories accredited by NABL before commencement of supply at their own expense on the sample drawn by the purchaser from the lot offered for first Stage Inspection.

21.5 In respect of the successful bidder, the purchaser reserves the right to demand repetition of some or all the type tests in presence of the purchaser's representative. In case the unit fails in the type tests, the complete supply shall be rejected. The bidders are therefore requested to quote unit rates for carrying out each type test, which however, will not be considered for evaluation of the offer.

22.0 Drawings:-

22.1 A set of following drawings with all dimensions shall be submitted by the Bidder along with the offer:

- i. General Dimensional drawing.
- ii. Core Assembly drawing.
- iii. Internal Construction Drawing
- iv. Rating & Diagram Plate Drawing.
- v. HV/LV Bushings indicating measurement of creepage distances.
- vi. Operation and Maintenance Manual.

22.2 The drawings shall be of A-3 (420 x 297 mm) size only. The bidder should also supply along with his offer the pamphlets/literatures etc. for fittings / accessories.

22.3 The bidder should not change design once offered as per A/T, Approved drawings and Type Test Reports.

22.4 The successful Bidders shall submit complete set of Drawings (as listed in Cl.No.22.1) of transformer in triplicate indicating dimensions to **CE (Stores)** for approval and get approved it before offering Ist stage inspection.

23.0 Rejection :-

23.1 Apart from rejection due to failure of the transformer to meet the specified test requirements the transformer shall be liable for rejection on any one of the following reasons.

- i. No Load & Full Load Losses exceeds the specified values mentioned in Cl. No.6.3 above.
- ii. Impedance voltage value exceeds the Guaranteed value plus tolerances as mentioned at Cl.No.6.5 above.
- iii Type test are not carried out as per clause no. 21.0 of the specification.
- iv. Drawings are not submitted as per clause no. 22.0 of the specification.
- v. GTP not submitted as per clause no. 25.0 of the specification.
- vi Heat dissipation calculation sheet are not submitted as per clause no.7.0 of the specification.

24.0 Cleaning and Painting.

- i. The surface of the tank shall be properly pre-treated / phosphated in a seven tank process and shall be applied with a powder coating of 40 micron thickness. The powder coating shall be of Aircraft Blue colour (shade No. 108) for transformers. Powder coating shall be suitable for outdoor use. The seven tank process facility shall be enhance to ensure proper quality for outdoor application.
- ii. The month and year of supply shall be painted in red bold **Marathi** lettering at two places, one on conservator and other at sum conspicuous place on the transformer which shall be clearly visible from the ground.

25.0 Guaranteed & Technical Particulars:

The bidder should fill up all the details in GTP parameter list, the statement such as “as per drawings enclosed”, “as per MSEDCL’s requirement” “as per IS” etc. shall be considered as details are not furnished and such offers shall liable for rejection.

26.0 Testing facility

The bidder should have adequate testing facility for all routine and acceptance tests and also arrangement for measurement of losses, resistance, etc. details of which will be enumerated in the tender.

27.0 Submission Routine Test Certificate

a. The successful bidder shall submit the routine test certificate along with documentary evidence for having paid the Excise Duty for the following raw materials viz. Oil, Aluminum, copper for conductors, insulating materials, core materials, bushings at the time of routine testing of the fully assembled transformer

b. Instruction and operation Manual

The successful bidder shall be required to submit 5 copies of instruction and Operation manual for each lot of 100 Transformers (or part thereof) supplied. This instruction manual should give complete details about the pre-commissioning tests/checks and the details of preventive maintenance etc.

28.0 Stage Inspection :-

28.1 Supplier shall give 15 days’ advance intimation to the **Chief Engineer (Stores)** and S.E. (Store/Adm) to organize stage inspection in which assembly of core, windings and other core materials etc. would be inspected. In respect of raw materials such as core stamping, winding conductor, oil etc. successful bidder shall use these materials manufactured/supplied by the standard manufacturers and furnish the manufacturer's test certificates, as well as, proof of purchase from those manufacturers documentary evidence for having paid the excise duty for the information of the department.

28.2 **Chief Engineer (Stores) will depute representatives from testing and inspection wing at the time of stage inspection.**

28.3 10 % of the transformers from the offered lot will be tested for acceptance tests at factory, in the presence of purchaser's representative before dispatch.

28.4 The inspection may be carried out by the purchaser at any stage of manufacture. The successful bidder shall grant free access to the purchaser's representatives at a reasonable time when the work is in progress. Inspection and acceptance of any equipment under this

specification by the purchaser shall not relieve the supplier of his obligation of furnishing equipment in accordance with the specifications and shall not prevent subsequent rejection if the equipment is found to be defective.

28.5 The purchaser may at its option, open a transformer supplied to the Stores, in presence of supplier at site or at Stores. If any of the technical particulars are seen to be in variance than the guaranteed technical particulars, the whole lot of transformer will be rejected without any liability on purchaser.

28.6 In addition to the above, the purchaser may pick up any transformer and decide to get it type tested from any laboratory accredited by NABL at purchaser's cost. The Bidder will have to organize packing of the transformer at company's Stores for which they will be paid necessary charges. If the transformer fails to meet the requirement of type tests, the quantity of transformers ordered on them will be forthwith rejected and the purchaser may purchase these transformers at the risk and cost of the supplier.

29.0 Testing of all Distribution Transformers for no load and full load losses

After inspection of new transformers at factory for acceptance of the lot, all distribution transformers from the lot will be tested for no load and full load losses at all stores. Tenderer has liberty to be present at the time of testing.

30.0 Random Sample Testing (RST)

The tenderer should intimate to **C.E. (Stores)**, M.S.E.D.C.L of completion of dispatches of whole lot of Distribution Transformers to stores against this tender. **C.E. (Stores)**, M.S.E.D.C.L for will select the stores for Random Sample Testing (RST) and depute E.E. (Testing) to carry out RST of the lot.

E.E. (Testing) will select a transformer from the lot of transformers already tested for No load & full load losses. 15 days advance intimation will be given to tenderer for joint inspection. The date of RST will not be altered to the convenience or request of supplier. If supplier's representative fails to attend on the date fixed for RST, the RST will be carried out in his absence and results of RST will be binding on supplier. In case the selected transformer fails in any of the tests, complete lot of transformers will be rejected.

31.0 Inspection & Testing of Transformer Oil:

The tenderer shall make arrangements for testing of transformer oil to be used in the transformers and testing will be done in presence of purchaser's representative.

To ascertain the quality of transformer oil, original manufacturer's test report should be furnished to EE (Testing) at the time of factory inspection for acceptance of the lot.

32.0 Quality Assurance

32.1 The bidder shall invariably furnish following information along with the offer failing to which the offer will be rejected.

32.2 Certificates of following materials.

- i. Aluminum and copper conductor
- ii. Transformer oil
- iii. Core
- iv. Insulating paper.
- v. Porcelain Bushings
- vi Steel Plate used for Tank

- 32.3 Names of the supplier for the raw material, list of standard accordingly to which the raw materials are tested, list of test normally carried out on raw materials in presence of bidder's representatives, copies of type test certificates.
- 32.4 Information and copies of test certificate as in (i) above respect of bought out accessories including terminal connectors.
- 32.5 List of manufacturing facilities available. In this list the bidder shall specifically mention whether lapping machine, vacuum drying plant, air conditioned dust free room with positive air pressure for provision of insulation and winding etc are available with him.
- 32.6 Level of automation achieved and list of areas where manual processing still exists.
- 32.7 List of areas in manufacturing process where stage inspection are normally carried out for quality control and details of such tests and inspections.
- 32.8 Special features provided in the equipments to make it maintenance free
- 32.9 List of testing equipment available with the bidder for final testing of transformers and test plant limitation, if any, vis-à-vis the type, special acceptance and routine tests specified in the relevant standards and the present specification. These limitations shall be very clearly brought out in Schedule – D i.e. schedule of deviations from specified test requirements.
- 32.10 The successful bidder shall submit the Routine Test Certificate along with documentary evidence having paid for the excise duty for the following raw materials viz Oil, Aluminum for conductors, insulating materials, Core materials, Bushing at the time of routine Testing of the fully assembled transformer.

33.0 Qualifying Requirement: As per Tender

34.0 Final Inspection

10 % of the transformers offered will be tested for all tests without opening the transformer. Heat Run Test will have to be carried out on the transformer having maximum no load and full load losses taken together. **Chief Engineer (Stores) will depute representatives from testing and inspection wing at the time of final inspection.**

35.0 Performance Guarantee:

All transformers supplied against this specification shall be guaranteed for a period of 66 months from the date of receipt at the consignee's Stores Center or 60 months from the date of commissioning, whichever is earlier. However, any engineering error, omission, wrong provisions, etc. which do not have any effect on the time period, shall be attended to as and when observed/ pointed out without any price implication.

36.0 COST DATA SHEET:-

The bidders shall submit the cost data sheets indicating the break up prices and quantity of each raw material and components along with the unit rates required for manufacture the offered transformers along with the offer. The cost data sheet format is enclosed herewith.. If the rates quoted are not justified with the cost data sheets, the offer shall not be considered for evaluation and placement of the order.

The cost data sheets shall be scrutinized by MM cell section.

FORMAT FOR COST DATA	
ITEM	----- KVA , ----- KV DISTRIBUTION TRANSFORMER

Sr. No.	PARTICULARS	UNIT	UNIT RATES Rs.	QTY	AMT (Rs.)
1	CORE (M4 or better)	KG			
2	ALUMINIUM/COPPER WITH DPC FOR HV WINDING	KG			
3	ALUMINIUM/COPPER WITH DPC FOR LV WINDING				
3	INSULATION PAPER	Meter			
4	OIL	LTRS			
5	TANK	NO			
6	CHANNELS	KG			
7	INSULATORS/BUSHINGS	KG			
8.	OTHERS	LUMP SUM			
				TOTAL	
	WASTAGE @ %				

37.0 Schedules

37.1 The bidder shall fill in the following schedules, which form part of the tender specification and offer. If the schedules are not submitted duly filled in with the offer, the offer shall be rejected.

Schedule `A' -Guaranteed Technical Particulars

Schedule `B' -Schedule of Tenderer's Experience.

37.2 The discrepancies between the specification and the catalogs, Literatures and indicative drawings which are subject to change, submitted as part of the offer, shall not be considered and representation in this regard will not be entertained.

37.3 The Bidder shall submit the list of orders for similar type of equipments, executed of under execution during the last three years, with full details in the schedule of Tenderer's experience (Schedule `B') to enable the purchaser to evaluate the tender.

Schedule `A'

GUARANTEED TECHNICAL PARTICULARS

As indicated in E-Tendering GTP Parameter

SCHEDULE – 'B'

SCHEDULE OF TENDERER'S EXPERIENCE

Tenderer shall furnish here a list of similar orders executed/under execution by him to whom a reference may be made by Purchaser in case he considers such a reference necessary.

Sr. No.	Name of client & Description.	Value Of Order (along with cap. of T/F)	Period of supply & commissioning	Name & Address to whom reference may be made.
1	2	3	4	5

NAME OF FIRM _____

NAME & SIGNATURE OF TENDERER_____

DESIGNATION_____

DATE _____

Annexure I

Air Pressure Test

Name of Supplier:

Order No.:

Capacity & Voltage Ratio of Distribution Transformer : _____ kVA, ____/0.433 kV

Vector Group Dyn11

Sr. No. of equipment Tested:

Date of Testing:

Reference Standard

All the opening of the transformer tank were closed with suitable gasket, bushing, valves and plugs. The compressor pipe connected at oil filling hole on conservator and a pressure gauge was fitted at air vent plug. The parallel string were places around the tank, the distance between string and tank as shown in following diagram were recorded before applying the pressure and after releasing pressure.

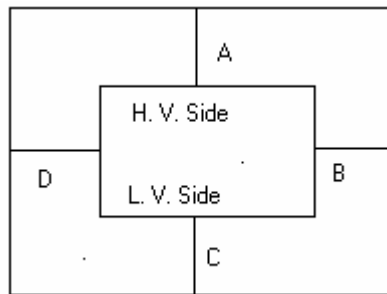

Tank Thickness: Side _____ mm. Top & Bottom _____ mm

Test Pressure : _____ kg/cm² applied for 30 Minutes.

Test Point	Distance before Test In mm	Distance after release of Pressure in mm	Deflection In mm
A			
B			
C			
D			

Permanent Deflection : _____ mm

Permissible Limit of Permanent Deflection as per Specification : _____ mm

Test witnessed by

Tested by

Annexure II

Unbalance Current Test

Name of Supplier:

Order No.:

Capacity & Voltage Ratio of Distribution Transformer : _____ kVA, ____/0.433 kV

Vector Group Dyn11

Sr. No. of equipment Tested:

Date of Testing:

Reference Standard

Transformer Secondary terminals 2U, 2V & 2W are shorted. The shorted 2U, 2V & 2W is connected to 2N through Ammeter. The primary terminals 1U, 1V & 1W are connected to supply. The rated current _____ A is fed to primary and unbalance current is noted on Ammeter.

Unbalance Current Measured in Ammeter : _____ A

Rated current in Secondary Side : _____ A

Permissible limits as per specification : 2% of the Rated current in Secondary Side

% of Unbalance current with reference to Rated current in Secondary Side

$$= \frac{\text{Unbalance Current} \times 100}{\text{Rated current in Secondary Side}}$$

=

=

Test witnessed by

Tested by

LV Winding : Since the resistance of LV winding is less than 0.005 ohm, Temperature Rise in LV Winding is taken as temperature rise of oil as per clause no. 4.3 of IS:2026 (Part II)/1977

Temperature Rise in LV Winding = _____ °C

HV Winding Resistance across 1U1V at _____ °C = _____ ohm

Measurement of Hot Resistance of HV Winding after Shut Down.

Time	Resistance

Hot winding Resistance at Ambient Temperature _____ °C (from graph) = _____ Ohm

Temperature Rise in H. V. Winding is

$$= \frac{\text{Hot Resistance} \times (235 + \text{Cold Ambient Temperature})}{\text{Cold Resistance}} - (235 + \text{Hot Ambient Temperature})$$

=

=

Results :

- 1) Temperature Rise in Oil = _____ °C
- 2) Temperature Rise in LV Winding = _____ °C
- 3) Temperature Rise in HV Winding = _____ °C

Test witnessed by

Tested by

Three phase , conventional type 200 kVA, 22/ 0.433 kV & 11/0.433 kV Distribution Transformer Without CSP feature

Sr.No.	GTP Parameter	
1	Name of Manufacturer .	T
2	Reference Standard	T
3	Whether transformer is Oil Natural Air Natural cooled type (Yes/ No)	B
4	Whether transformer is suitable for Indoor /Outdoor installation	T
5	Rating of transformer in KVA	N
6	Primary Voltage in kV	N
7	Secondary Voltage in kV	T
8	Whether neutral is solidly earthed (Yes/ No)	B
9	Colour of transformer	T
10	Vector Group	T
11	Approximate overall length of transformer in mm	N
12	Approximate overall breadth of transformer in mm	N
13	Approximate overall height of transformer in mm	N
14	Approximate length of transformer tank in mm	N
15	Approximate breadth of transformer tank in mm	N
16	Approximate height of transformer tank in mm	N
17	Thickness of the side of transformer Tank plate in mm	N
18	Thickness of the bottom of transformer tank plate in mm	N
19	Thickness of the top of transformer tank plate in mm	N
20	Weight of Tank & fittings in kgs	N
21	Total Weight of Transformer in kgs	N
22	Type of Tank (corrugated/conventional)	T
23	Degree of slope to the top plate of Transformer.	T
24	In case of Corrugated tank, Thickness of corrugated sheet (in mm)	T
25	Name plate details are as per the requirement specified in tender. (Yes/ No)	B
26	No of radiators provided and location with arrangement	T
27	Thickness of the radiator of transformer in mm	N
28	No of radiator fins .	T
29	Total radiating surface of transformer tank in Sq. mtrs.	N
30	Core material used & its grade	T
31	Type of core	T
32	Weight of Core in kgs	N
33	No. of steps of core for CRGO core	N
34	Diameter of core in mm	N
35	Effective core area.(sq.cm)	N
36	Flux density in Tesla	N
37	Thickness of core lamination in mm	N
38	The temperature shall in no case reach a value that will damage the core itself, other parts or adjacent materials (Yes/No)	B
39	Type of connection for H.V. Winding (Delta) (Yes/ No)	B
40	Type of connection for L.V. Winding (Star) (Yes/ No)	B
41	Material of H.V. winding	T
42	Material of L.V.Winding	T
43	Insulation provided to H.V. winding.	T
44	Insulation provided to L.V. winding.	T
45	Current density of H.V. winding (in Ampere/ sq.mm)	N
46	No of LV winding turns	N
47	No of HV winding turns	N
48	Resistance of LV winding per phase at 20 deg C in ohms	T
49	Resistance of HV winding per phase at 20 deg C in ohms	T
50	Current density of L.V. winding (in Ampere/sq. mm.)	N

51	Clearance between Core & L.V. winding in mm	N
52	Clearances between L.V. & H.V. winding in mm	N
53	Clearances between HV Phase to Phase in mm	N
54	Clearances between end insulation to Earth in mm	N
55	Clearances between winding to tank in mm (min 30 mm)Yes/No	B
56	Weight of Aluminum in kgs	N
57	Inter layer insulation provided in H.V winding to design for Top & bottom layer	T
58	Inter layer insulation provided in L.V winding to design for Top & bottom layer	T
59	Inter layer insulation provided in between all layer in H.V winding	T
60	Inter layer insulation provided in between all layer in L.V winding	T
61	Details of end insulation	T
62	Whether wedges are Provided at 50% turns of the Coil (Yes/ No)	B
63	Insulation materials provided for core	T
64	Length of coil used for HV winding in meter.	N
65	Cross section area of the coil used for HV winding (sq.mm)	T
66	Length of coil used for LV winding in meter.	N
67	Size of strip used for LV winding in mm	T
68	No. of conductors in parallel for LV winding	N
69	Total cross section area of LV conductor in sq. mm	N
70	No. of H.V coils /phase	N
71	Thickness of locking spacers between H.V. coils (in mm)	N
72	Weight of Oil in kgs	N
73	Volume of Oil in Ltrs	N
74	Quantity of total oil absorption (in liters) in first filling	N
75	Total oil Volume including Total Oil absorption in liters	N
76	Grade of Oil used.	T
77	Name of Oil manufacturers to be supplied.	T
78	Breakdown Values of Oil at the time of first filling (kV/mm) considering 2.5 mm gap	T
79	Conservator tank to the transformer with oil level indicator (showing three levels) and drain plug is provided (Yes/ No)	B
80	Drain Valve (20 mm) provided to the transformer tank (Yes/No)	B
81	Earthing terminals with lugs is provided (Yes/No)	B
82	Lifting lugs provided (Yes/No)	B
83	Oil filling hole with cap (on conservator) is provided (Yes/No)	B
84	Thermometer pocket is provided (Yes/No)	B
85	Quantity of Silica-Gel filled in breather (in gm)	N
86	Material of HV and LV Bushings and makes thereof	T
87	Reference standard of Bushings	T
88	Rating of L.V. Bushing	T
89	Minimum Creepage Distance of HV Bushing in mm (min.25 mm per kV)	N
90	Minimum Creepage Distance of LV Bushing in mm (min.25 mm per kV)	N
91	Rating of H.V. Bushings (in kV)	N
92	Rating of L.V. Bushing (in kV, kA)	T
93	Min. External clearances of H.V. bushing terminals between ph. to ph (255 mm)	B
94	Min. External clearances of H.V. bushing terminals between ph. to earth (140 mm)	B
95	Min. External clearances of L.V. bushing terminals between ph. to ph (75 mm)	B
96	Min. External clearances of L.V. bushing terminals between ph. to earth (40 mm)	B
97	Rating of Lightning Arrestors and Make thereof	T
98	Reference Standard of Lightning Arrestors.	T
99	Maximum winding temperature rise in °C over an Ambient temp. of 50°C by Resistance Method	N
100	Maximum temperature rise of Oil in °C over an Ambient temp. of 50°C by thermometer.	N
101	Magnetizing current (No load) in Amps and its % of full load current at rated voltage referred to L.V. side.	T
102	Magnetizing current (No load) in Amps and its % of full load current at maximum voltage (112.5% of rated voltage) referred to L.V. side.	T
103	No load losses at rated voltage and rated frequency (Watts) .	N
104	Full Load losses at 75°C (Watts)	N

105	Efficiency at 75 °C at unity P.F. at 125% load	N
106	Efficiency at 75 °C at unity P.F. at 100% load	N
107	Efficiency at 75 °C at unity P.F. at 75 % load	N
108	Efficiency at 75 °C at unity P.F. at 50% load	N
109	Efficiency at 75 °C at unity P.F. at 25% load	N
110	Efficiency at 75 °C at 0.8 P.F. lag at 125% load	N
111	Efficiency at 75 °C at 0.8 P.F. lag at 100 % load	N
112	Efficiency at 75 °C at 0.8 P.F. lag at 75 % load	N
113	Efficiency at 75 °C at 0.8 P.F. lag at 50 % load	N
114	Efficiency at 75 °C at 0.8 P.F. .lag at 25% load	N
115	Efficiency at 75 °C at 0.8 P.F. leading at 125% load	N
116	Efficiency at 75 °C at 0.8 P.F. leading at 100% load	N
117	Efficiency at 75 °C at 0.8 P.F. leading at 75% load	N
118	Efficiency at 75 °C at 0.8 P.F. leading at 50%load	N
119	Efficiency at 75°C at 0.8 P.F. leading at 25 % load	N
120	Regulation at Unity P.F (in %)	N
121	Regulation at 0.8 P.F. lag. (in %)	N
122	Regulation at 0.8 P.F. leading. (in %)	N
123	% Impedance value at 75°C	N
124	Separate source power frequency withstand test for HV for 1 minute in kv(min)	T
125	Separate source power frequency withstand test for LV for 1 minute in kv(min)	T
126	Induced over voltage withstand test for 1 min. specify voltage frequency, time for test.	T
127	Impulse test value (in kVp) .	T
128	Type test report of L.T. circuit breaker used in CSP submitted alongwith offer in physical form & soft copy	B
129	The test certificates of Aluminium/copper conductor, core , insulating paper, porcelain bushings, steel plate used for enclosure of offer transformer is enclosed along with the offer in soft copy.(Yes/ No)	B
130	All type test report of type tests carried out on transformer at NABL laboratory shall be submitted along with the offer as per cl. XXII (c) of Section (I) i.e. Instructions to tenderers. (Yes/ No)	B
131	Unbalance current test, Air pressure test and temperature rise test shall be conducted as per format enclosed with the technical specification along with the offer (Yes/ No)	B
132	All drawings shall be furnished for each offered item separately along with this offer (Yes/ No)	B
133	Oil absorption calculation sheet shall be furnished for each offered item separately along with this offer (Yes/ No)	B
134	Heat dissipation calculation shall be furnished for each offered item separately along with this offer (Yes/ No)	B
135	Flux density calculation sheet with no. of Primary & Secondary turns shall be furnished for each offered item separately along with this offer (Yes/ No)	B
136	Calculation sheet for 112.5% of Rated V/f ratio (over fluxing calculation sheet) shall be furnished for each offered item separately along with this offer (Yes/ No)	B
137	Required documents, plant and machinery, list of order executed/under execution shall be furnished for each offered item separately along with this offer (Yes/ No)	B
138	The information required under Quality Assurance shall be submitted with the offer in physical format & soft copy(Yes/ No)	B
139	The cost data in the prescribed format shall be submitted with offer in physical format & soft copy (Yes/ No)	B
140	The performance Guarantee of the transformers in years	N
141	Power frequency withstand voltage dry & wet in kV(rms) for H.V Bushing	T
142	Dry lightning Impulse withstand voltage test in kV (peak) Stating the wave form adopted for H.V. bushing	T

115

REF. STANDARD : IS 2026-1977 & IS 1380
3 STAR RATING, 3 PH. DISTRIBUTION TRANSFORMER

TYPE	OUT	ODCR	TYPE OF COOLING	ONAN
RATED KVA			OIL TEMP. RISE	35
RATED HV V	11000		WDG TEMP RISE	40
VOLTAGE LV V	433		VOLUME OF OIL	l
RATED HV A	---		MASS OF OIL	kg
CURRENT LV A	---		WEIGHT OF CORE	kg
PHASES	3		WEIGHT OF WDGs	kg
FREQUENCY Hz	50		TOTAL MASS	kg
IMPEDANCE %	---		SERIAL NO	
GUARANTEED TOTAL LOSS	Wdg Loss	Core Loss	--- IN WATTS	
INSULATION LEVEL	U75 AC 2B		CORE	CRGO/AMDT
VECTOR GROUP	Dyn-11		MONTH & YEAR OF MFG	--- & ---
OWNER	MSEDCL, MUMBAI.			
A/T.NO.				

CONNECTION DIAGRAM

VECTOR DIAGRAM

4 HOLES Ø3

RAJASHTRA STATE

DISTRIBUTION CO.

NOTE:

1. ACTUAL VALUES SHALL BE PUNCHED AT THE TIME OF DISPATCH.
2. RATING PLATE MATERIAL: ALUMINIUM ANODIZED
3. THICKNESS OF RATING PLATE: 18 SWG
4. WEIGHTS ARE SUBJECTED TO +10% TOLERANCE

THIS IS AN INDICATIVE DRAWING

NAME OF THE CUSTOMER: MSEDCL, MUMBAI-51
 A/T. NO. _____
 QUANTITY _____
 DETAILS OF DISTRIBUTION TRANSFORMER: ---KVA, 11/0.433KV

NAME OF THE MANUFACTURE & SYMBOL

DATE	RATING & TERMINAL MARKING PLATE	
DRN	---KVA, 11/0.433KV CRGO/AMDT, DIST. TRANSFORMER	
CHD	SCALE	DRG. NO
APPD		
	---KVA	NTS

CODE	DESCRIPTION	6 FEED	K (113)
A	LEG CENTER		
B	WINDING HEIGHT		
C	CORE DIA		
D	EFFECTIVE CORE AREA		
HY COIL	CONDUCTOR MATERIAL NO. OF COILS PER PHASE OUTER DIAMETER WITH INS INNER DIAMETER WITH INS AXIAL LENGTH CONDUCTOR CROSS SECTION CONDUCTOR DIA CONDUCTOR FILLET DIA NO. OF TURNS	EC GRADE ALUMINUM --- --- --- --- --- DPC ---	EC GRADE ALUMINUM
LV COIL	CONDUCTOR MATERIAL OUTER DIAMETER WITH INS INNER DIAMETER WITH INS AXIAL LENGTH EFFECTIVE CONDUCTOR CROSS SECTION CONDUCTOR SIZE NO. OF TURNS	Aluminum --- --- --- --- DPC ---	Aluminum
INSULATION			
H	WRAP ON CORE		
L	WEDGES BETWEEN HV & LV COILS		
N	CLEARANCE BETWEEN HV & LV COILS		
U	FRAME CHANGED INSULATION		
P	PHASE BANDS		
Q	END INSULATION BLOCK CLEARANCE TO TANKWALL FROM HV Wdg	25mm 30mm (Min)	25mm 30mm (Min)
R	CORE FRAME CHANNEL SIZE	75x40mm	75x40mm
S	BASE CHANNEL SIZE	75x40mm	75x40mm
T	NO. OF SPACES B/W HV AXIAL COIL	0	0
U	INTER PHASE CLEARANCE	10mm (Min)	10mm (Min)
V	THICKNESS OF SPACERS	15mm & 40mm	15mm & 40mm
W	TE RIG SIZE & NO	Ø12mm & 40mm	Ø12mm & 40mm
X	STUD SIZE & NO	LV	LV
RESISTANCE AT RIGID C (PER PHASE) %			
RESISTANCE AT RIGID C (PER PHASE) %			

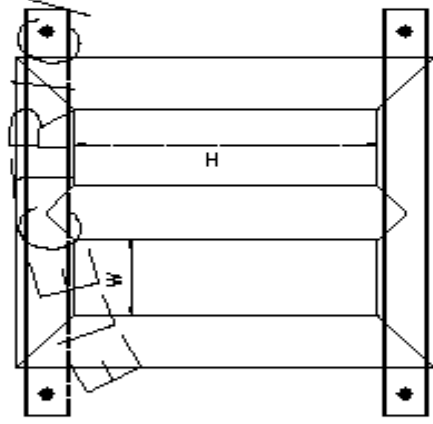

FRONT VIEW

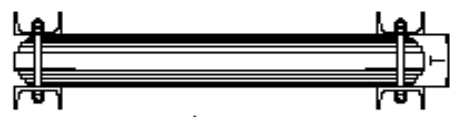

SIDE VIEW

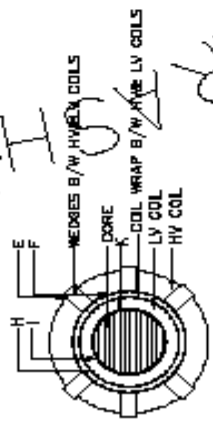
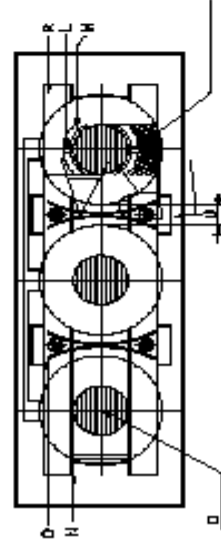
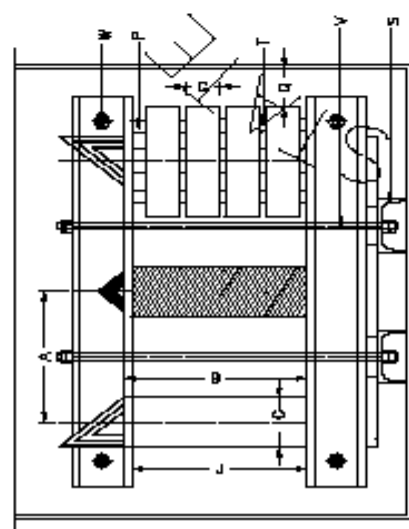

- NOTE:
- CORE CLAMPS ARE PARTED WITH WEDGES
 - WEDGES B/W HV & LV COILS
 - COIL WRAP B/W HV & LV COILS
 - LV COIL
 - HY COIL
 - WEDGES B/W HV & LV COILS
 - CORE
 - COIL WRAP B/W HV & LV COILS
 - LV COIL
 - HY COIL

NAME OF THE MANUFACTURE & SYMBOL

INTERNAL ARRANGEMENT DRWG

SCALE DRG.NO

100 3 50 1000 453 5.25 133.3 100 KVA NTS

THIS IS AN INDICATIVE DRAWING

NAME OF THE CUSTOMER: NEDCO, NARSA-81
 ART. NO.
 QUANTITY
 DETAILS OF DISTRIBUTION TRANSPORTATION: --- PEARL/DASS/COMP

TRANSFORMER BUSHING AS PER IS:3347

ELECTRICAL CHARACTERISTICS:

1. RATED VOLTAGE : 1 KV
2. RATED CURRENT : 250 Amp
3. POWER FREQUENCY WITHSTAND VOLTAGE : 3 KV
4. CREEPAGE DISTANCE : 25 MM. (MIN.)

NOTE:

PERFORMANCE REQUIREMENTS OF THE BUSHING SHALL CONFIRM TO IS: 3347

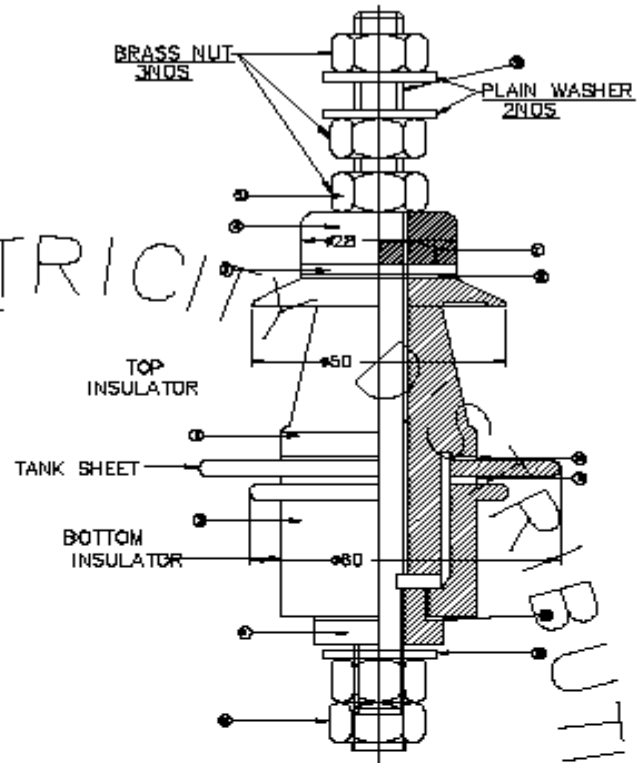

MAKE:-----/-----/-----

Sr. No.	DESCRIPTION	QTY
1	INSULATOR UPPER	1
2	INSULATOR LOWER	1
3	WASHER M12	2
4	TOP END WASHER	1
5	STEM WASHER	2
6	LOCKWASHER	2
7	SEALING WASHER (TYPE-A)	1
8	SEALING WASHER (TYPE-B)	1
9	SEALING WASHER (TYPE-C)	1
10	SEALING WASHER	1
11	LOCKWASHER	1
12	LOCKWASHER	1
13	LOCKWASHER	1
14	PLAIN WASHER M12	1
15	SEALING WASHER (TYPE-D)	1

NAME OF THE CUSTOMER: MSEDCL, MUMBAI-51
 A/T. NO. _____
 QUANTITY: _____
 DETAILS OF DISTRIBUTION TRANSFORMER: 100KVA, 11/0.433KV, CSP

NAME OF THE MANUFACTURE & SYMBOL _____

A/T. NO. _____

Note _____

BY: _____
BY: _____
DATE: _____

CHKD _____ APPD _____ DRG. NO _____

THIS IS AN INDICATIVE DRAWING

ELECTRICITY DISTRIBUTION

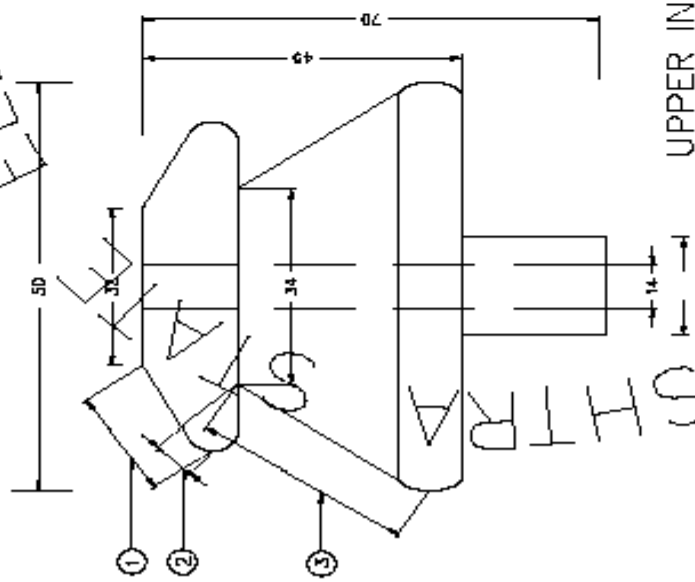

UPPER INSULATOR

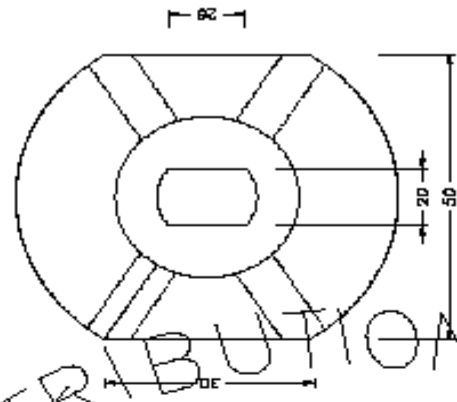
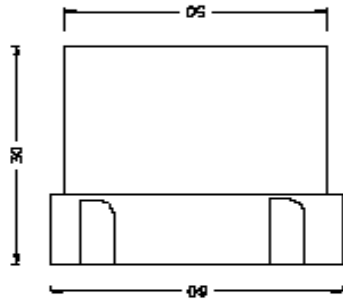

LOWER INSULATOR

NAME OF THE CUSTOMER: MSEDCL, MUMBAI-51
 A/T. NO.
 QUANTITY:
 DETAILS OF DISTRIBUTION TRANSFORMER: --KVA, 11/0.433KV, CSP

PT.No.	DIM
1	14
2	11
3	40

- NOTE:
1. COLOUR - BROWN GLAZED.
 2. CREEPAGE DISTANCE - 25mm/KV
 3. AS PER IS: 3347(PART-1/SEC)
 4. ALL DIMENSIONS IN mm

NAME OF THE MANUFACTURE & SYMBOL

A/T. NO.
 QTY.
 CREEPAGE DISTANCE DRAWING OF LV SUBSTATION TYPE/250/11KV.
 -MVA, 11KV/0.433KV, CSP
 CHD
 APPD
 DRG.NO

NOT TO SCALE
 THIS IS AN INDICATIVE DRAWING

SILICAGEL BREATHER

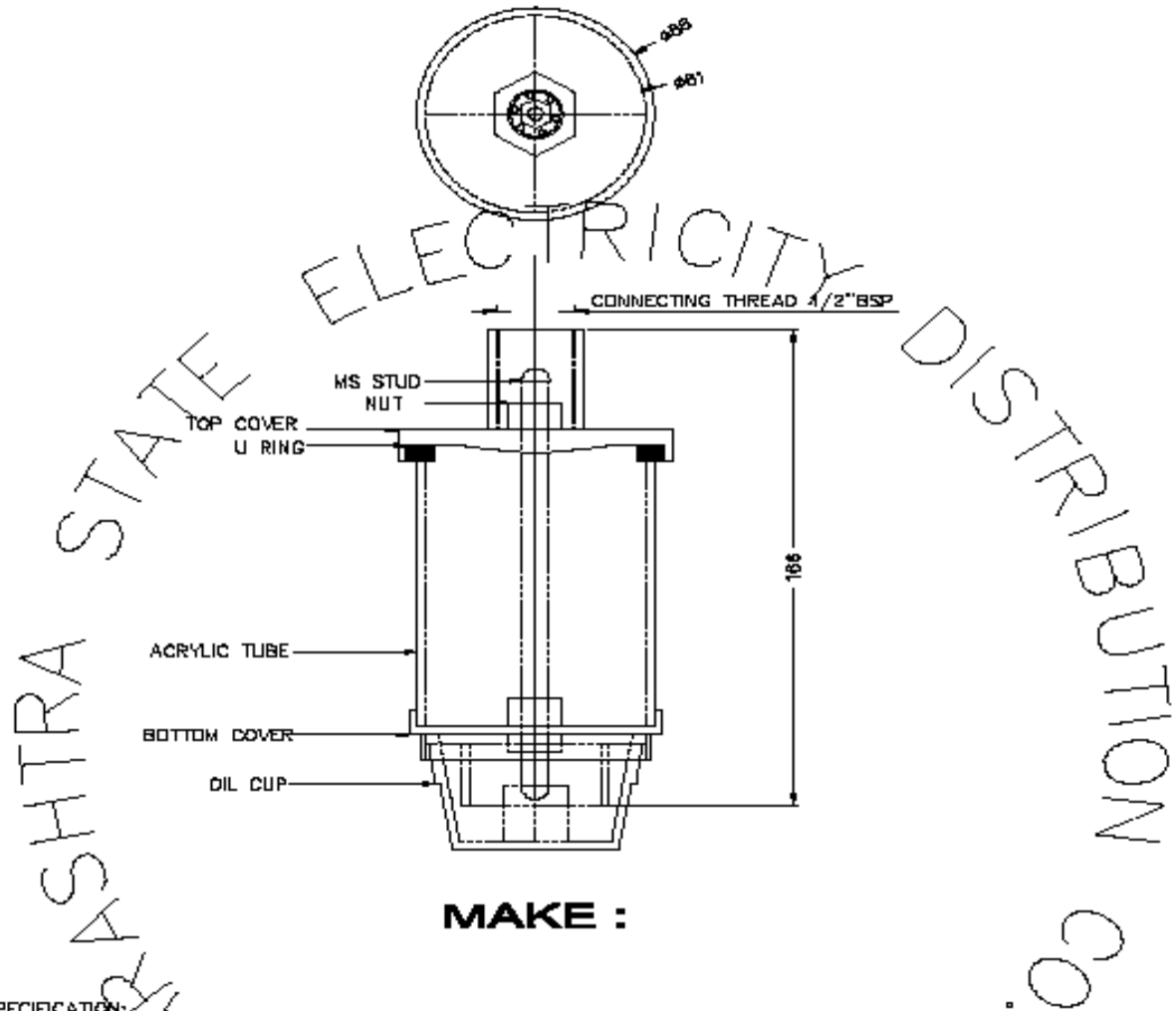

MAKE :

SPECIFICATION:

PART NAME	MATERIAL USED
TOP COVER	NYLON
BOTTOM COVER	NYLON
OIL CUP	ACRYLIC

NAME OF THE CUSTOMER: MSEDCL,MUMBAI-51
 A/T. NO. _____
 QUANTITY: _____
 DETAILS OF DISTRIBUTION TRANSFORMER: -- KVA,11/0.4-33KV,CSP

NAME OF THE MANUFACTURE & SYMBOL	
A/T.NO:	
Make:	
SILICA GEL BREATHER, 250gms	
CHD	DRG.NO
APPD	

THIS IS AN INDICATIVE DRAWING